





IT3G520/IT3G520W/IT3G520W-LR Network Camera

Quick Installation Guide

This guide describes the basic functions of IT3G520/IT3G520W/IT3G520W-LR Network Camera. All detailed information is described in the user's manual.

**Warning Before Install**

- **Power off the Network Camera as soon as it is found smoking or smelt unusual.**
 - **Keep the Network Camera away from the water. If the Network Camera is wet, power off immediately.**
-  Contact your distributor when such cases happen.
-  Contact your distributor when such cases happen.
- **Do not disassemble the Network Camera.**
 - **Refer to your user's manual for the operating temperature.**
 - **Keep the Network Camera away from the direct sunlight.**
 - **Do not place the Network Camera in high humid environments.**
 - **Do not drop the Network Camera.**
 - **Do not touch the Network Camera when it's lightning.**
 - **Do not place the Network Camera around the heat sources, such as television or oven.**
 - **Do not place the Network Camera on unsteady surfaces.**
 - **Do not insert any object into the Network Camera, such as needles.**
 - **3GPP/ISMA Function Ready. Applications depend on local ISP provider service!**

IT 3G520 Aluminium Housing Assembling

Components:



Step 1: Get the power wire through the bracket first.



Step 2: Then through out from the housing part, meanwhile insert the power cable to the appropriate socket.

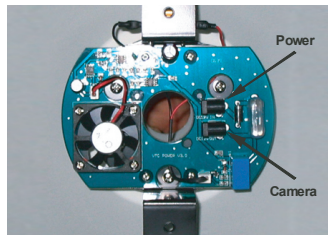

Step 3: Screw the dome on the fixing bridge.

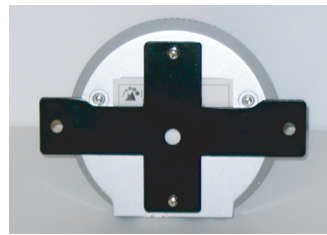

Step 4: Screw on the two side screws, and plug in the power of the dome.

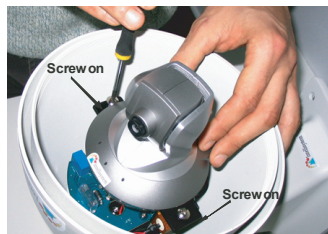

Step 5: Finally cover up, and the assembling is accomplished.



IT 3G520W Aluminium Housing Assembling

Components:



Step 1: Get the power wire through the bracket first.



Step 2: Then through out from the housing part, meanwhile insert and connect the power and camera cable to the appropriate socket.

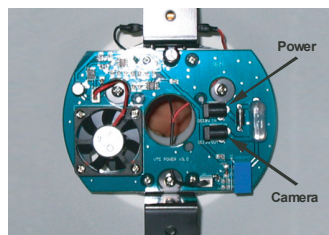

Step 3: Screw the dome on the fixing bridge.

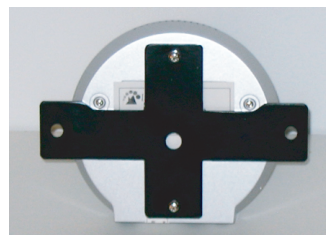

Step 4: Screw on the two side screws, and plug in the power of the dome.

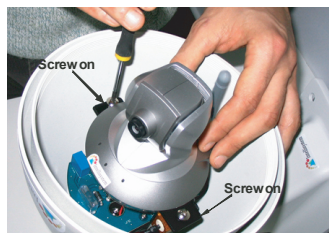

Step 5: Finally cover up, and the assembling is accomplished.



IT 3G520W-LR Aluminium Housing Assembling

Components:



Step 1: Get the power wire through the bracket first.



Step 2: Then through out from the housing part, meanwhile insert and connect the power and camera cable to the appropriate socket.

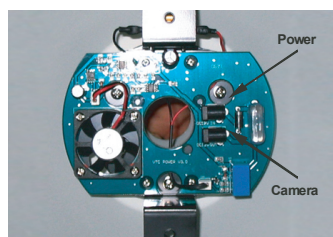

Step 3: Pass the cable of antenna through the hole in the bracket and screw on the antenna. Screw housing part into the bracket. Attention to the cables inside!



Step 4: Screw on the two side screws, and plug in the power of the dome.

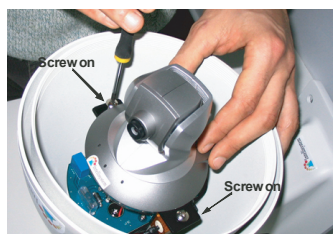

Step 5: Finally cover up, and the assembling is accomplished.

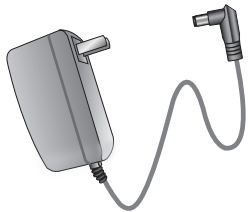
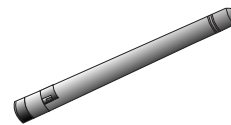

1 Check Package Contents**● Wired or Wireless Network Camera****● Power Adapter****● Software CD****● Antenna for wireless model only**

2 Physical Description

● Front Panel

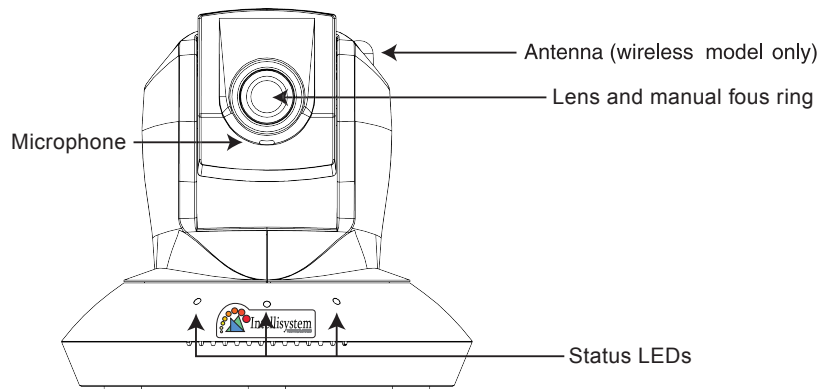

● Rear Panel

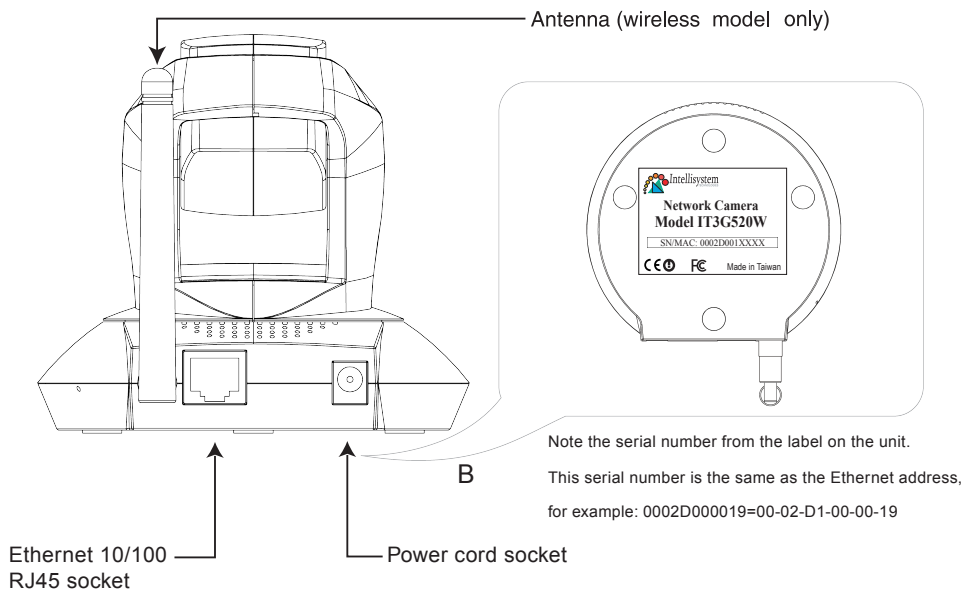

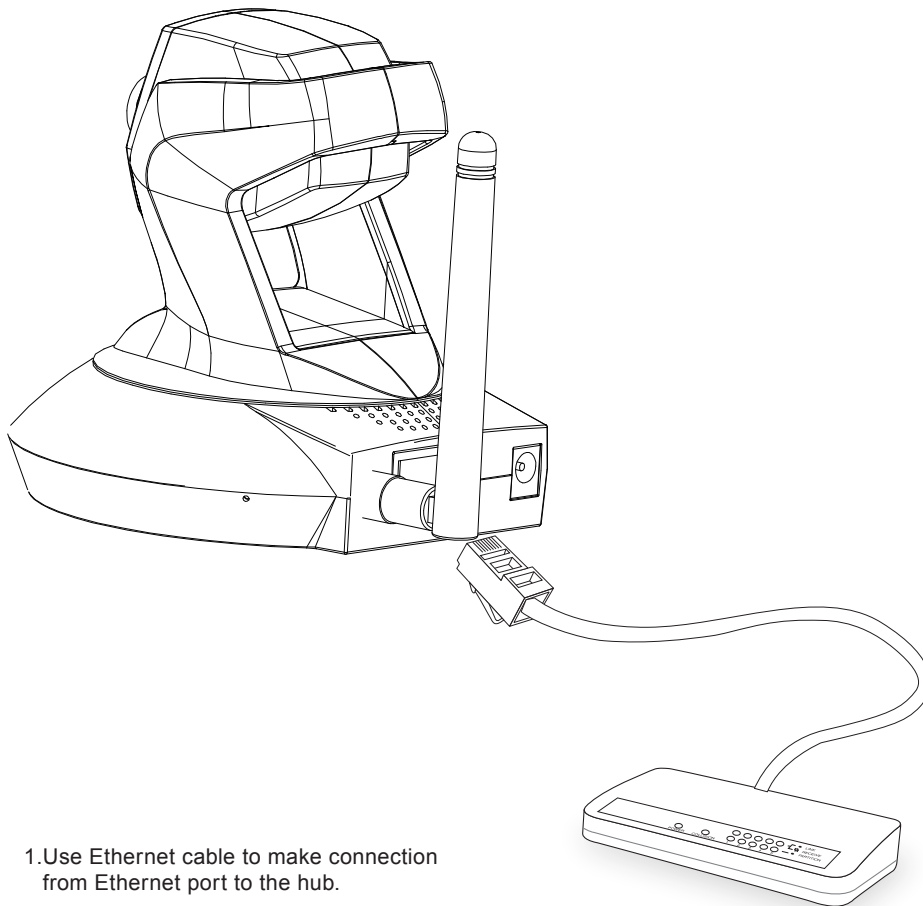
4**Install Your Network Camera in Ethernet Network**

1. Use Ethernet cable to make connection from Ethernet port to the hub.

* Use Category 5 Cross Cable when the Network Camera is directly connected to PC.

5 Assign IP Address

1. Run the Network Camera Wizard under the Software Utility directory from software CD.
2. The program will search the servers or cameras on the same LAN.

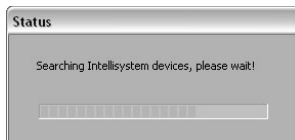

3. After searching, the main installer window will pop up. Click on serial number that matches the one you just noted from **2** Physical description

4. Click "Link to selected device(s)" to connect the Internet Explorer to the Network Camera.

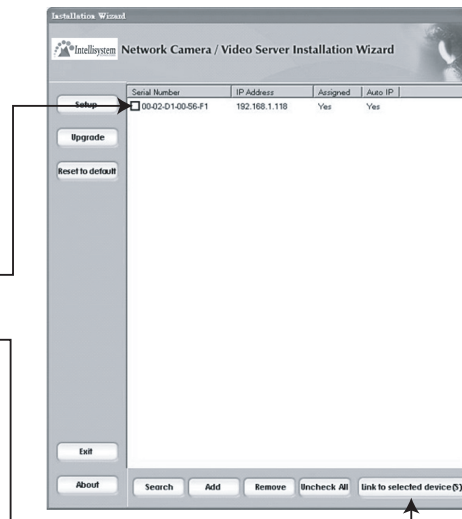

6 The Internet Explorer Connects to the Network Camera

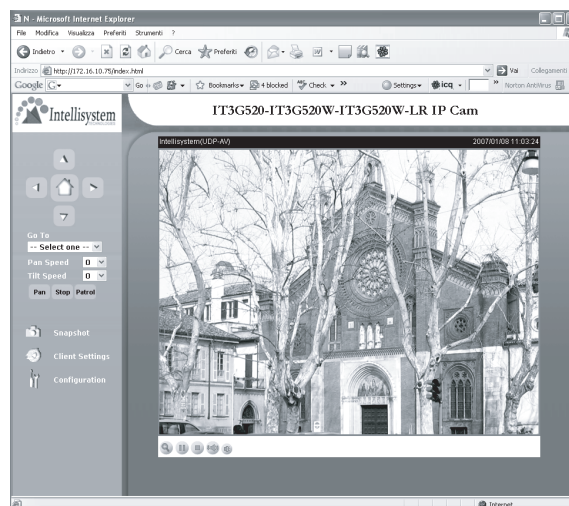

7 Set up Your Wireless Configuration for the Network Camera

(Wireless models only)

1. Check the SSID currently set on your wireless access point (AP).
2. Go to **Configuration > Wireless LAN**

3. Type in the SSID consistent with the setting on your AP.

4. Select the Wireless mode as "Infrastructure".

5. Click **Save**

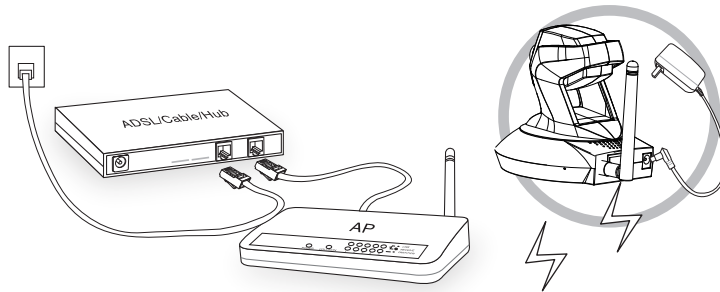
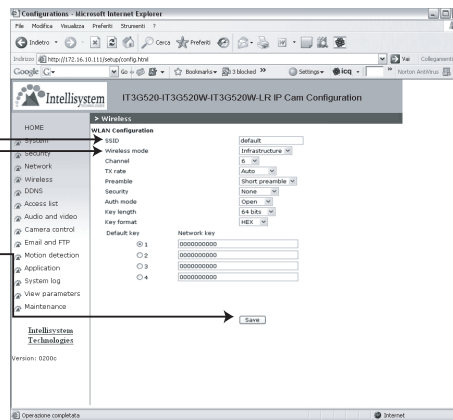

Note:

1. SSID abbreviated from Service Set Identifier is the name assigned to the wireless network. The camera's factory SSID setting is set to "default".
2. Select "Ad-Hoc" wireless mode if you want the camera to communicate without using an AP or wireless router.

For setup further configuration, please check user's manual on the software CD.

8 Client Settings (Windows 2000/Me/98E)

At the initial access to the "Connection type" page in Windows, the web browser will ask for a new plug-in installation, the plug-in being the Network Camera. This plug-in has been registered for certification and can be used to change the parameters at the client's site. The user may click on to install the plug-in. If the web browser does not allow the user to complete the installation, check the Internet security to lower the security level or contact your IT or networking supervisor.

1. Initial IE browser, select function item "Tools" → "Internet Options"

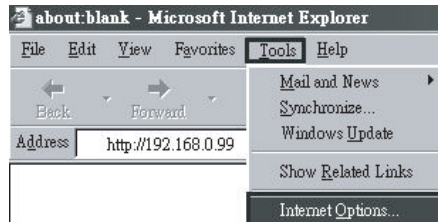

2. Security → Default Level

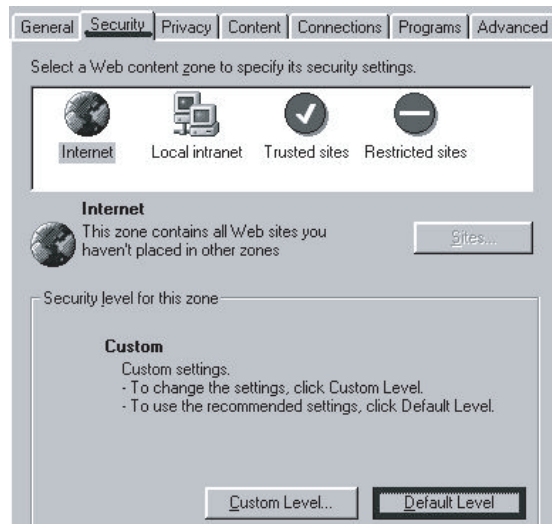

3. Lower down the security level bar to "Low", and press "Apply"

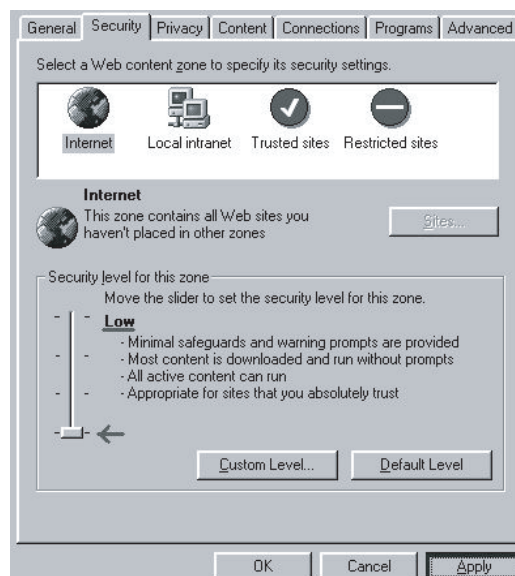

4. Refresh IE Browser, a question frame will pop-up to ask for download Active-X, press "Yes".

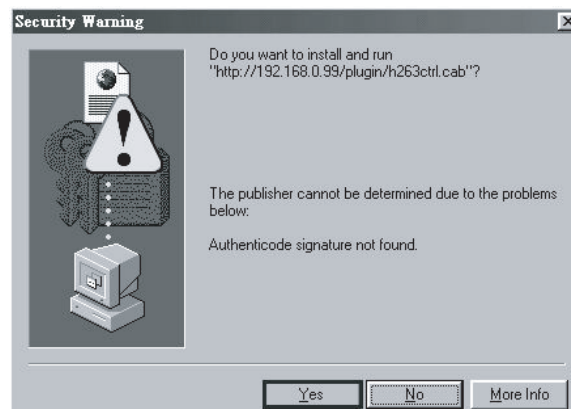

9

Client Settings (Windows XP)

1. Initial IE browser, select function item "Tools" → "Internet Options"

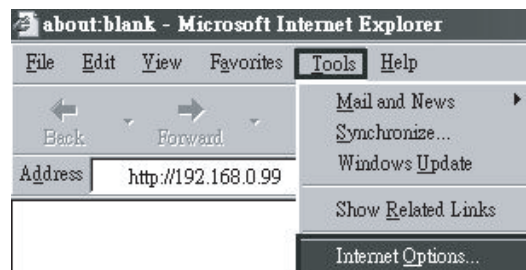

2. Security → "Custom Level"

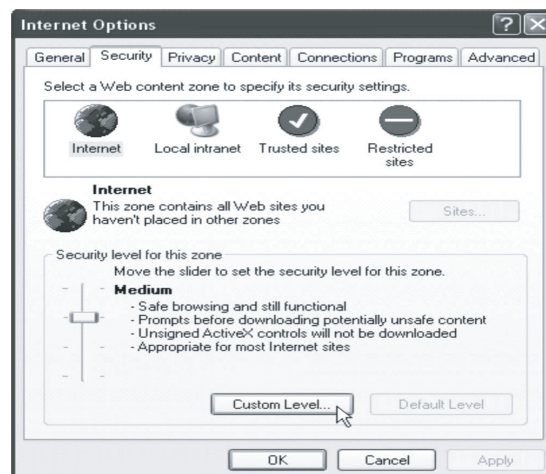

3. Security Settings→ Download unsigned ActiveX Controls set "Enable" and press "OK"



4. Press "Apply" and then "OK"

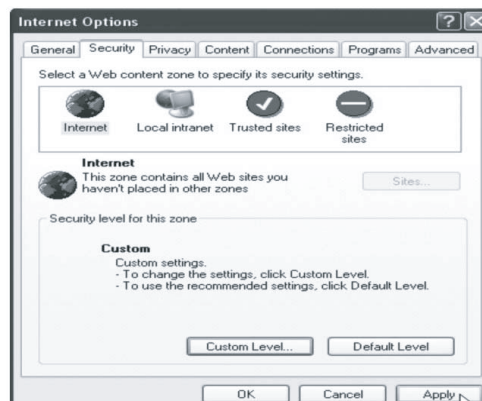

5. Key-In camera's IP address and press "OK" on Information Bar.



6. Click the blue bar under the Camera's IP address in the browser, then choose "Install ActiveX Control"

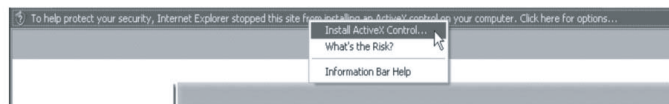

7. Recover security settings. Download unsigned ActiveX Controls set "Disable" and press "OK" and "Apply"

